

# PYLE

## OWNER'S MANUAL

### PLTSN74



**TOUCH SCREEN 7" MONITORIZED TFT/LCD  
IN-DASH MONITOR WITH DVD/CD/MP3 PLAYER  
AND AM/FM/TV TUNER**

[www.pyleaudio.com](http://www.pyleaudio.com)

# Contents

*Thank you for buying this product.*

Please read through these operation instruments so you will know how to operate your model properly. After reading please keep this booklet in safe place for future reference.

## 1 Before You Start

- Important Safeguards* 4
- About this manual* 4
- Precautions* 5
- Maintenance* 5
- Location & function of the controls* 7
- Remote control* 8
- Specifications* 8

## 2 Installation

- Wiring Connections* 11
- Install the Unit* 12

## 3 Common Operations

- Reset the Unit* 14
- Turning the Unit On/Off* 14
- Volume Control* 14
- Setting the Sound Characteristics* 14
- EQ Setting* 14
- Turning Loudness On* 15
- Eject a Disc* 15
- Open the Monitor* 15
- Angle Setting* 15
- Mute Function* 15
- Clear* 15
- Mode Selector* 15
- Menu Setup Button* 15
- Sensor* 15
- Eject a Disc Compulsively* 15

## 4 Main Menu

- Main Menu Setup* 18
- Audio Adjust* 18
- Video Adjust* 17
- Source Setup* 18
- Others* 18

## 5 DVD

- Playing a DVD* 21
- DVD Setup* 21
- Selecting Tracks Fast* 21
- Stop the Playback* 21
- Pause the Playback* 21
- Selecting Tracks/FF/FREW* 21
- Number Buttons* 21
- Repeat Playing* 21
- System Switch* 22
- Slow Motion Playback* 22
- Increase Picture Size* 22
- On Screen Display* 22
- Setting the Playback Time* 22
- Changing the Viewing Angle* 22
- Changing Audio Language* 22
- Changing the Subtitle Language* 22
- Selecting Menu* 22
- DVD Setup Menu* 22

# Contents

## 6 MP3

- Playing a MP3 Disc* 30
- Selecting Tracks/F.F/F.REW* 30
- Repeat Playing* 30
- Number Buttons* 30
- Stop Playing* 30
- Selecting Mp3 Tracks* 30
- Pause the Playback* 31
- Skip Backward/Forward/F.F/F.REW the Playback* 31
- On Screen Display* 31

## 7 VCD/CD

- Playing a VCD/CD Disc* 32
- Selecting Tracks/F.F/F.REW* 32
- Repeat Playing* 32
- Playing Tracks at Random* 32
- Number Buttons* 32
- Stop Playing* 32
- Pause the Playback* 32
- Skip Backward/Forward/F.F/F.REW the Playback* 32
- System Switch* 33
- Slow Motion Playback* 33
- Increase Picture Size* 33
- On Screen Display* 33
- Setting the Playback Time* 33
- Selecting Channel* 33
- Selecting Title* 33
- Program Playing* 33

## 8 Tuner

- Listening to the Radio* 35
- Band Selector* 35
- Manual/Automatic Tuning* 35
- DX/LOC Selector* 35
- Selecting the Stored Station* 35
- MO/ST Selector* 35
- Scanning/Memorizing Stations Automatically* 35
- Number Buttons* 35
- On Screen Display* 35

## 9 TV (optional)

- On Screen Display* 37
- TV Station Selector 1* 37
- TV Station Selector 2* 37
- Frequency Searching* 37
- Adjusting Frequency Manually* 37
- TV Setup Menu* 37

## 10 Additional Information

- Simple Troubleshooting Guide* 38

## IMPORTANT SAFEGUARDS

- 1 Be sure to connect the color coded leads according to the diagram. Incorrect connections may cause the unit to malfunction or damage the vehicle's electrical system.
- 2 Be sure to connect the speaker (-) leads to the speaker (-) terminal. Never connect the left and right channel speaker cables each other or to the vehicle body.
- 3 Make sure all the connections are completely correct before turning on your unit.
- 4 When replacing the fuse(s), the replacement must be of the same amperage as shown on the fuse holder.
- 5 Do not block vents or radiator panels. Blocking them will cause heat to build up inside and may result in fire.
- 6 To lest the driver distract his attention from, please install the unit in an apt place.
- 7 Using the unit after starting the engine, otherwise the unit can not be started, because the electric energy of battery was used up.
- 8 The unit must be screened from direct sunlight, or the electric energy of battery will be wasting for the high temperature.
- 9 Do not use the unit in extreme high temperature or such low temperature conditions, and also avoid humidity and direct sunlight.
- 10 Take care of the magnetism of the unit. Do no put the credit card, cassette or watch around the unit, or they would be broken or some information in them lose.
- 11 To lest disturb the video frequency, keep far away from the unit when using your phone.
- 12 Do not put the remote control under high temperature or where the sun strikes it, or else the control remote can not work normally.

## About this manual

This unit features a number of sophisticated functions ensuring superior operation. All the functions have been designed for the easiest possible use, but many are not self-explanatory. This manual will help you understand the functions and operations of the unit. This manual main explains **remote control operation**. However, in addition to those functions related with DVD/VCD/CD/MP3 operation that can only be operated by the remote control, there are also functions can be operated by the buttons provided for the main unit.

# Before You Start

## PRECAUTIONS

This unit can play the following discs only:

Type of disc	Label on the disc	Recorded material	Size of disc
DVD		Sound and moving pictures	12cm
VCD		Sound and moving pictures	12cm
CD		Sound only	12cm
MP3		Sound only	12cm

**NOTE:** The unit is compatible with VCD1.0/2.0/3.0 version and DVCD disc.

- **Do not attempt to modify the unit, modifying the unit may cause an accident.**
- **Stop the vehicle before carrying out any operation that could interfere with your driving.**
- **Do not work in extremely high or low temperature. Be sure the temperature inside the vehicle is between +60° C and -10° C before turning on your unit .**
- **To enjoy optimum sound and images while playing, handle the discs as follows:**

—Handle the disc by its edge to keep the disc clean, and do not touch the surface.



—Do not use your CDs with paste residue or ink attached.



—Do not use CDs with labels or stickers attached, which may leave a sticky residue while beginning to peel off.  
(Shown as the picture)



—Clean the discs with an optional cleaning cloth. Wipe each disc from the center out.  
(Shown as the picture)

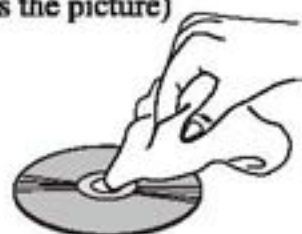

Besides playing the discs above, the unit also can be connected to other connector. Please refer to the details on page 18 before you playing them.

# Before You Start

## Maintenance

### Replacing the Fuse

Make sure the amperage matches the specified value when replacing the fuses. If the fuse is blown, check the power connection and replace with a new one. If the same problem occurs, it would be subjected to the malfunction. In such cases, please consult to the nearest service dealer.

#### **Warning**

*Never use the fuse with the rated amperage more than that supplied to your unit, otherwise it will damage the unit.*

### Replacing the Battery

When the range of the operation of the card remote control becomes short or no functions while operating. Replace the lithium battery with a new button cell (CR2025). Make sure the battery polarity before replace.

Gently pull out the Battery Holder while pressing the Stopper.



Put the button-type battery with mark(+) upward into the Battery Holder.

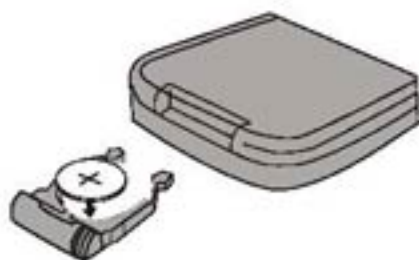

Insert the Battery Holder into the Remote Control.



### Precautions on Using Lithium Battery

Always keep the lithium battery beyond children's reach. In case swallowed, see a doctor immediately.

Cleaning the battery with a dry cloth, to ensure its perfect connected.

Make sure the proper polarity when loading with the battery.

To prevent short circuit, do not use metal tweezers to clip the battery.

#### **Warning!**

*Improper handle with the battery may lead to explosion. It cannot be charged, disassembled or thrown into a fire.*

# Before You Start

## Location of the Controls

### The Expanding

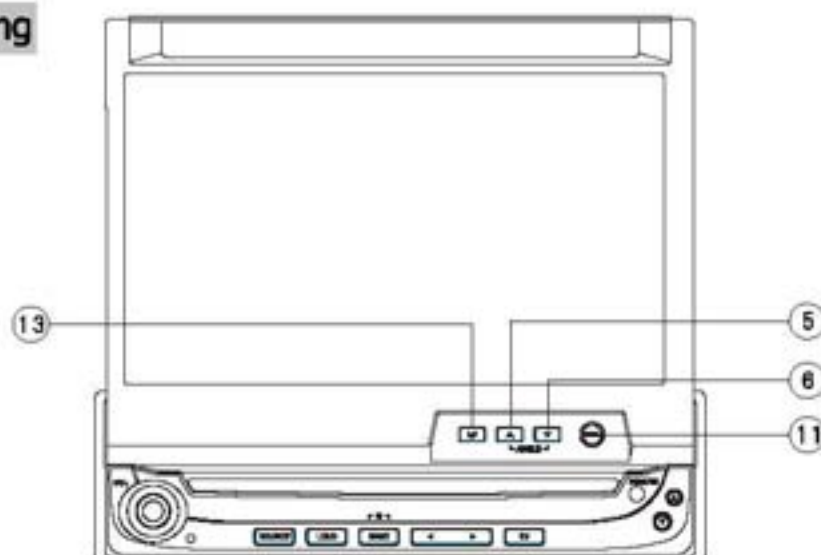

### The Whole

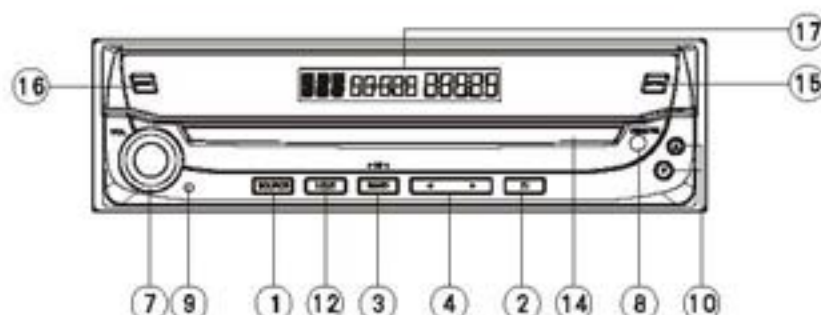



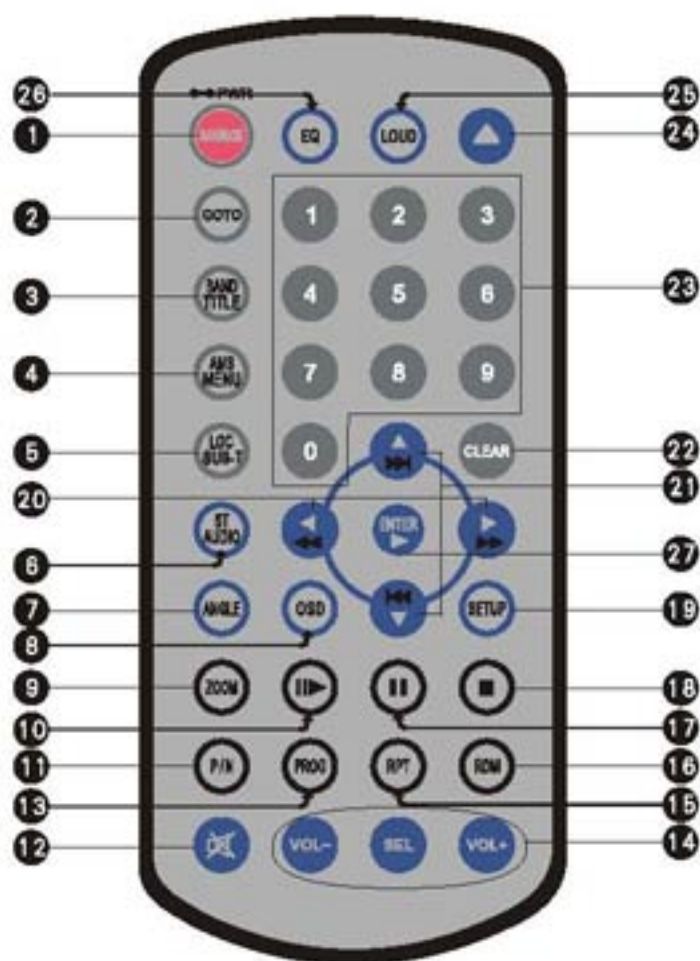





- |  |  |
|--|--|
| <p>① <b>SOURCE</b><br/>Brief press to select radio mode or playback mode, hold and press it to turn the unit on or off.</p> <p>② <b>EJ</b><br/>Press to eject a disc.</p> <p>③ <b>BAND/▶  </b> (band selector/play/pause) Button</p> <p>④ <b>◀ / ▶</b> ([Left/F.F]/[Right/F.R]) Button</p> <p>⑤ <b>▲</b> (ANGEL+) Button</p> <p>⑥ <b>▼</b> (ANGEL-) Button</p> <p>⑦ <b>VOL+ / VOL- / SEL</b></p> <p>⑧ <b>REMOTE</b> Infrared Sensor</p> <p>⑨ <b>RESET</b> Button</p> | <p>⑩ <b>▲ / ▼</b> ([Up/Next track]/[Down/Previous track])</p> <p>⑪ <b>⊖</b> (MENU) Button<br/>Brief press to set DVD menu during playback mode, brief press it to set the radio menu during radio mode, hold and press to set the main menu.</p> <p>⑫ <b>LOUD</b> (Loudness control) Button</p> <p>⑬ <b>⏪</b> (Back Space) Button</p> <p>⑭ <b>Disc Loading Slot</b></p> <p>⑮ <b>OPEN</b> Button</p> <p>⑯ <b>MUTE</b> Button</p> <p>⑰ <b>LCD Screen</b></p> |
|--|--|

**Remote Control****Tips:**

For more information as to replacing battery, please refer to **Replacing the Battery** on page 6.



# Before You Start

- ① SOURCE/POWER
- ② GOTO (playing time/track)
- ③ BAND/TITLE
- ④ AMS/MENU
- ⑤ LOC/SUB -T
- ⑥ ST/AUDIO (mono or stereo/language or channel selector)
- ⑦ ANGLE
- ⑧ OSD  
Brief pressing it to display the current information; keep pressing it to display the current setup information.
- ⑨ ZOOM (to increase the picture)
- ⑩  ( Slow Forward/Reward)
- ⑪ P/N( system adjusting)
- ⑫  Mute
- ⑬ PROG(Program playing)
- ⑭ VOL+ /VOL- /SEL
- ⑮ RPT(Repeat Playing)
- ⑯ RDM (Playing Tracks at Random)
- ⑰  (Pause/Play)
- ⑱  (Stop Playing)
- ⑲ SETUP
- ⑳  (F.F/F.R)
- ㉑  (Previous/Next Track)
- ㉒ CLEAR
- ㉓ 0~9 (Number) Buttons
- ㉔  (Eject Button)
- ㉕ LOUD (Loudness)
- ㉖ EQ
- ㉗  (Left/Right/Up/Down ENTER)

## Specifications

### General

Power Requirement	14.4V DC (11-16V allowable)
Load Impedance	4Ω
Max. Power Output	60W x 4
Tone Controls	±10dB Bass 100Hz Treble 10KHz
Dimensions	Approx. 160x178 x 50 mm (d/w/h)
TFT Sizes	Approx. 170 x 117.5x16.5 mm (d/w/h)
Angle between folded and unfolded	30~100
Weight	Approx. 2.55kg

### FM Section

Tuning Range (Optional)	87.5-108(MHz) (Europe) 87.5-107.9(MHz) (U.S.A.) 65-74(MHz) (Russia)
IF Range	10.7MHz
Usable Sensitivity (-30dB)	10dBuV
Signal-to-noise Ratio	50dB
Stereo Separation	30dB (1KHz)
Frequency Response	20Hz-10KHz

### AM Tuner Section

Frequency Range (Optional)	522-1620(KHz) (Europe) 530-1710(KHz) (U.S.A.)
IF Range	450KHz
Usable Sensitivity (-20dB)	32dBuV

### DVD/VCD/CD Player Section

VCD Signal System	AUTO/PAL/NTSC
Frequency Response	20Hz to 20KHz
Signal-to-noise Ratio	60dB
Separation	55dB(1KHz)
Distortion	1%

### TV Tuner (Optional)

Tuning Range	48.25-863.25(MHz)
Signal System	PAL/NTSC

**Note:**

**Due to continuous product improvement, specifications and design are subject to change without prior notice.**

# Installation

## Wiring Connection

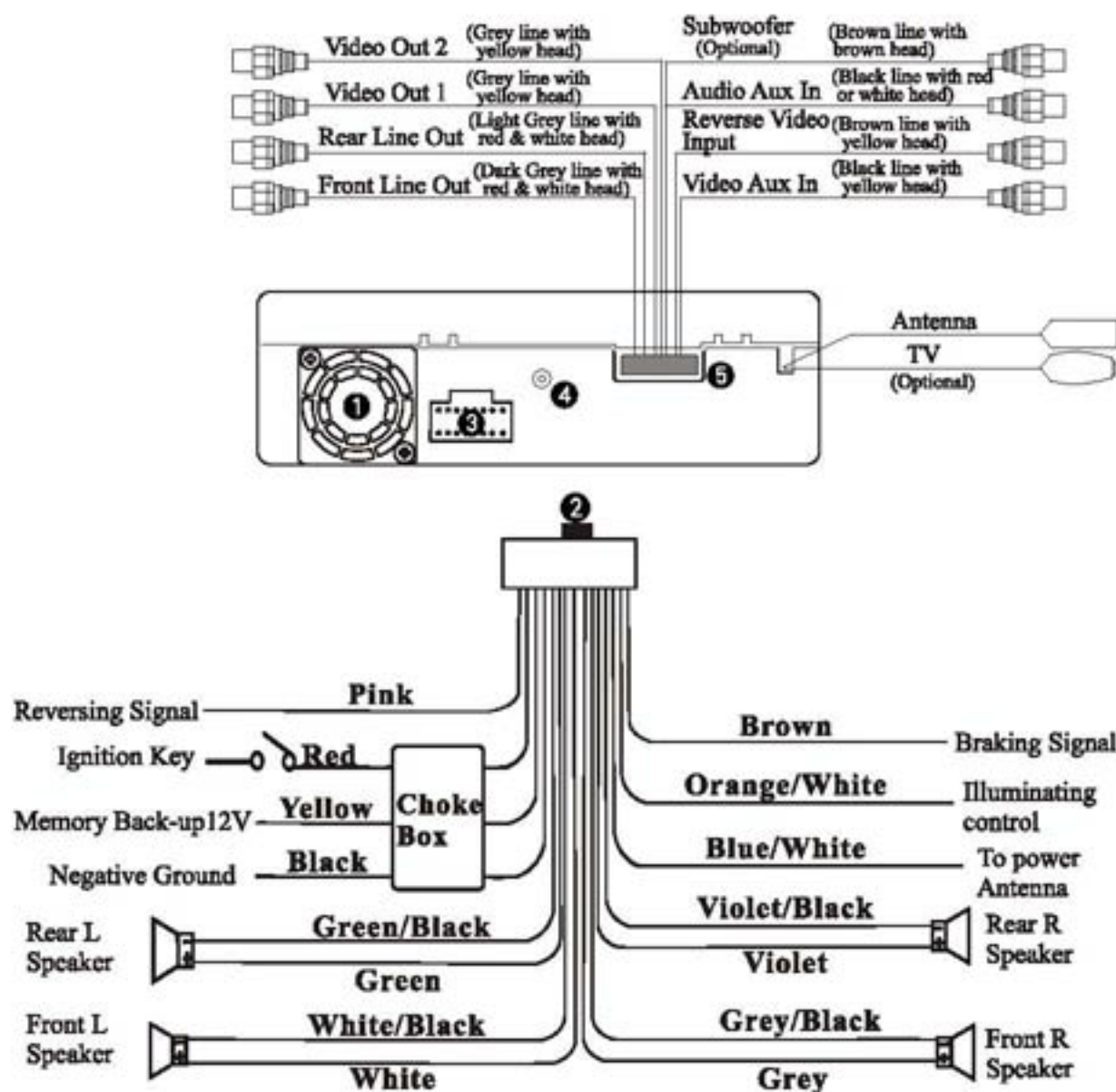

- |                         |                     |
|-------------------------|---------------------|
| ❶ Fan Window            | ❷ Output Plug(Male) |
| ❸ Output Socket(Female) | ❹ Screw Hold        |
|                         | ❺ Wire Clip         |

### Note:

- \* The brown wire is connected with brake signal; for safety, the programs can be seen on the monitor after braking the car, but the menu and RCA output are free of it. If you do not want to use this function, connect it with the negative pole.

## Install the Unit

### Parts List

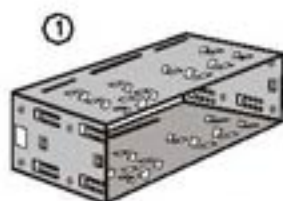

Mounting Sleeve x1



Rear Mounting Bolt x1



Harness Rubber x1



M4x3 & M5x5  
4 Screws Each



Outer Trim Frame x1



Connecting Wire x1



Steel Bar x1

### Installation Method ①: DIN Front-Mount

Panel

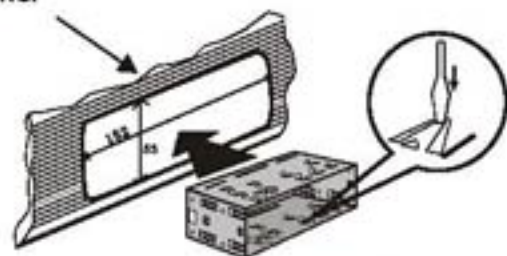

Bend these claws outward for a tight fit, if necessary.

1

Install two M5x6 screws on both sides (left and right) of the lock hook brackets



2

Install the unit with four M2x2 screws

3

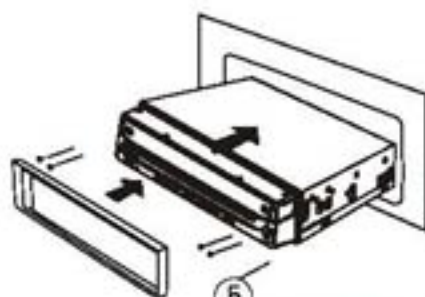

4

Install Outer Trim Frame

To support the unit

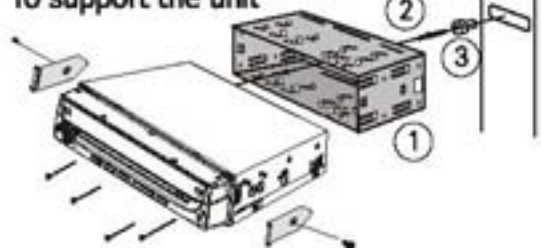

Fire Wall

# Installation

## Install the Unit

### Installation Method

Installation using the screw holes at the sides of the unit.

Select a position where the screw holes of the mounting bracket supplied with the car and the screw holes of the main unit become aligned (are fitted), and tighten the screws (see ④ at 2 places on each side). And then fasten them to the car.

- Note:  
Outer Trim Frame ⑤ and Mounting Sleeve ① are not used for installation method.

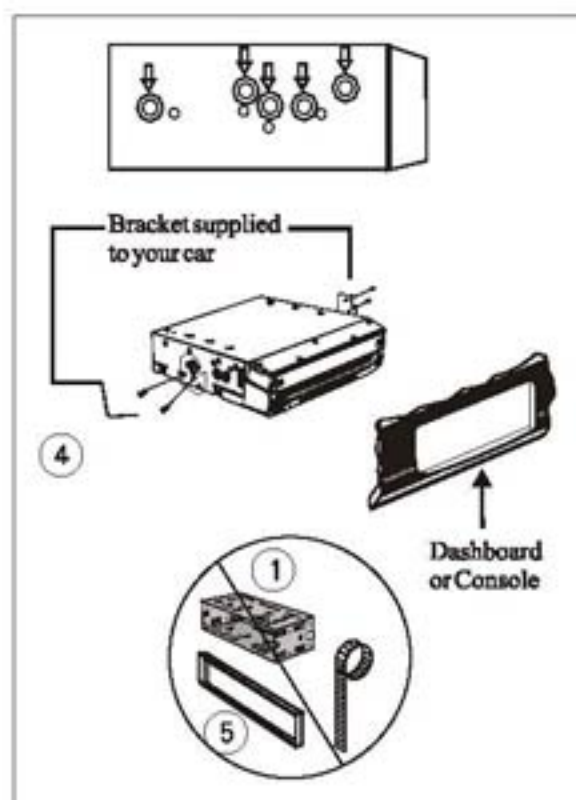

## Detach the Unit

1. Remove the outer trim frame.

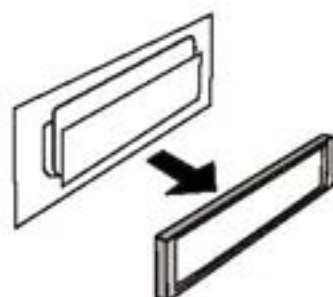

⑤

2. Screw the 4 screws, pull the head unit out.



# Common Operations

## Reset the Unit

Operating the unit for the first time or after replacing the car battery, you must reset the unit.

Remove the front panel at first, and then Press **9** **RESET** button in the panel with a pointed object, (such as a ballpoint pen) to set the unit to initial status.

### Note:

- When some errors occur on the display, you can also press **RESET** button to resume to normal, and it will erase the clock setting and some memorized functions.
- This function can only be operated by the head unit.

## Turning the Unit On/Off

Press **1** **PWR** button to turn on the unit, press it again, the unit is still in the waiting status. When insert a disc, the unit will automatically start playing. Keep pressing it more than 0.5 seconds to turn off the unit completely.

### Note:

- Pressing **SOURCE** button on the head unit also performs the same operation.
- During playback status, it will play automatically after inserting a disc.

## Volume Control

Press **4** **VOL+** button to increase the sound level and press **5** **VOL-** button to decrease the sound level.

### Note:

- Rotating **7** on the head unit also performs the same operation.

## Setting the Sound Characteristics

Repeatedly press **6** **SEL** button to select the desired mode in the following order:

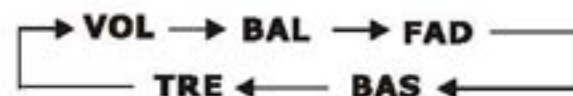

After selecting the desired mode, you can adjust the current level by pressing **4** **VOL** buttons.

### Note:

- Pressing **7** button and rotating it on the head unit also performs the same operation.

## EQ Setting

While listening to the popular music, classic music or rock music, you can select the corresponding preset modes to adjust the sound quality perfectly by using **26** **EQ** button.

Repeatedly keep pressing **26** **EQ** button to choose the following modes in turn:

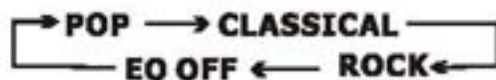

The default setting is OFF.

### Note:

- This function is operated by using the remote control.

## Turning Loudness On/Off

keep pressing **25** **LOUD** button activate loud function. You can press this button to increase the low frequency, which can improve sensitivity for your ears. Keep pressing it again to quit this function.

### Note:

- Pressing **LOUD** on the head unit performs the same function.

# Common Operations

## Eject a Disc

Press **②** EJ button to eject or insert a disc.

**■ Note:**

- \* Pressing **▲** on the remote control performs the same function.

## Open the Monitor

Press **⑬** OPEN button to slant the monitor, press and hold it again, the monitor will return to initial status..

**■ Note:**

- \* Pressing **▲** on the remote control performs the same function.
- \* The unit is running after the monitor telescopes into.

## Angle Setting

Press **⑤** ▲ and **⑥** ▼ to adjust the best position of the monitor. Press ▲ to adjust monitor backward by definite angle, press ▼ to adjust it forward.

**■ Note:**

- \* when adjusting the monitor angle, please press this button, or the monitor would be broken.
- \* This function is only operated by using the head unit.

## Mute Function

Press **⑫** MUTE button to shut off the sound output. And “” appears on the LCD. Press it again to resume to previous volume level.

**■ Note:**

- \* Pressing MUTE on the head unit also performs the same operation.

## Clear

If input some wrong selection, press **⑫** CLEAR button to clear it.

**■ Note:**

- \* This function is only valid on remote control.

## Mode Selector

Repeatedly briefly pressing **①** SOURCE button to select radio mode or playback mode.

**■ Note:**

- \* Briefly pressing SOURCE on the head unit also performs the same operation.

## Menu Setup Button

During DVD MENU SETUP/RADIO MENU SETUP mode, press **⑫** on the remote control to select the option, then press **⑫** ENTER to enter. You also can press **⑤** ▲ and **⑥** ▼ to select the menu, press **⑪** MENU to enter, and press **⑬** ↵ to back out the previous menu.

## Infrared Sensor:

Receptor **⑧** on the head unit for the card remote commander.

## Eject a Disc Compulsively

During playback, if it can not be played normally or the disc can not eject, briefly press SOURCE button to switch to the radio mode, hold and press the EJ button 3 seconds, the disc will be eject compulsively.

## Set up Main Menu

When the unit is on, the monitor will display the menu as follows:



Hold and press **SETUP** on the remote control or **MENU** on the head unit, or press **MENU** in the monitor to enter the menu as follows:



This menu includes **AUDIO**, **VIDEO**, **SOURCE**, **SYSTEM**, **EXIT**. Press them in the monitor to set the desired status.

**Note:**

- Press and hold **SETUP** or press **MENU** on the head unit to set up this menu; press them in the monitor to select the option.

### 1.Audio Adjust

After selecting **AUDIO**, the sub menu will appear as follows:



You can adjust **VOLUME**, **BALANCE**, **FAD**, **BASS**, **TREBLE**. For example, press **FAD**, the setting menu will appear as follow:



Press **◀** and **▶** to adjust the desired **FAD** level, press **EXIT** to exit this menu.

**Note:**

- Adjusting the other options perform the same operation.



# Main Menu

## 2.Video Adjust

After selecting VIDEO, the sub menu will appear as follows:



In this menu you can adjust CONTRAST, COLOR, TINT, BRIGHT, PICTURE, EXIT.

## Picture Adjust

Press PICTURE in this menu, it will appear as follows:



Press **←** and **→** to adjust the size, then press SAVE to save the setup, press EXIT to exit this menu.

### Note:

- Adjusting the other options perform the same operation.

## 3.Source Adjust

In the main menu, press SOURCE in the monitor, the sub menu will appear as follows:



You can adjust RADIO, DVD, AUX and TV to ON or OFF, press the corresponding button to set.

If one of them was set OFF, that function is null. For example, to set the RADIO OFF, press SOURCE can not activate reception of a radio. But can not set the current playback OFF.

## 4.System Adjust

After selecting SYSTEM, the sub menu will appear as follows:



In this menu you can adjust CLOCK SYSTEM, KEY BEEP, MONITOR FLEX and so on.

### ⌘ Clock System



Press **CLOCK SYSTEM** in the monitor to set **12 HOUR** or **24 HOUR** in this menu.

### ⌘ Key Beep



In this menu you can adjust **KEY BEEP**, press it in the monitor and select **ON** or **OFF**, the default setting is **ON**, it means when you press the keys, they sounded.

### ⌘ Monitor Flex



In this menu you can adjust **MONITOR FLEX**, press it in the monitor and select **MANUAL** or **AUTO**, the default setting is **AUTO**, it means the monitor will flex automatically.

### ⌘ Next Setup

Press **+** to display the menu follows, press **-** to display the previous one.



### ⌘ Reverse Pola



Setting **REVERSE POLA** in this menu. The signal is **+12V** when you back a car, please press **BATTERY** in the monitor; if the signal is **0V**, please press **GROUND**.

### ⌘ Subwoofer

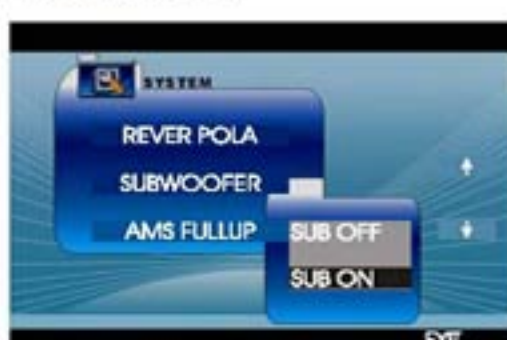

In this menu you can adjust **SUBWOOFER**, press it in the monitor and select **ON** or **OFF**, the default setting is **ON**.

# Main Menu

## AMS Fullup



In this menu to set the modes of AMS. When the setup is ON, the presettable stations are full, no new' s is allowed. When you select OFF, it will searching continually.

Press **+** to display the menu follows, press **+** to display the previous one.



To set the above options as the same operation.

## Local Area



You can select EUROPE or USA to search the stations quickly by your current area, also, you can select FM ONLY to receive the FM stations only.

## Local



In this menu to search the LOCAL stations, when selected ON, the strong signal local stations can be received, when selected OFF, the week signal out-of-town stations may be received.

## Goto FREQ



To select ON, you can using GOTO button on the remote control to select a station' s frequency directly in radio mode.



(Picture 1)



(Picture 2)

Press + in picture 1 or press + in picture 2 to enter the following menu:



## Adjust Screen



Press ADJUST SCREEN to display the above menu, there are a square button in the top left corner and a tip: *please press the button*. Press the square button at place ①, then the button will move to place ②, press it at place ②, it will move to place ③, then place ④, press SAVE at last.

## Clock Adjust





Press CLOCK ADJUST in the monitor to adjust the clock.

# DVD

## Playing a DVD

Insert a DVD disc into the slot ⑭, the unit will automatically switch on, if a DVD disc is loaded, press **SOURCE** to start the playback.

### Note:

- You can eject a DVD by pressing EJ button on the base or  on the remote control or  in the monitor.

At the beginning of playing DVD, the monitor will display the menu as follows:

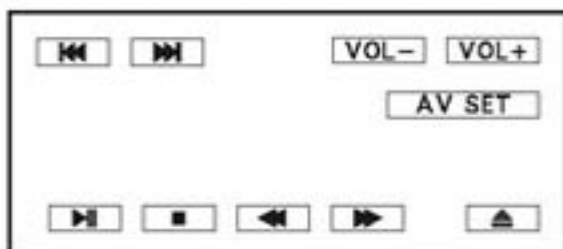

### Note:

- This menu appears by touch the monitor.

## DVD SETUP

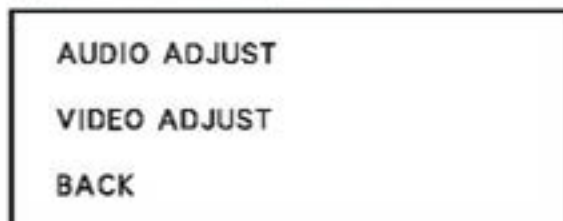

During DVD playback, select AV SET will appear the following menu:







### Note:

- For more details please refer to pages 16 to 17.
- To adjust VIDEO ADJUST, a DVD should be inserted and played normally at first.

## Selecting Tracks Fast

During DVD playback, press ⑳  to play the backward track, firstly press ㉑  to replay the previous track. Press ㉒  again within 3 seconds to play next track.

### Note:



- Pressing  and  button on the head unit or also  and  in the monitor perform the same operation.

## Stop the playback

During DVD playback, firstly press ㉓ , then press ㉔ or ㉕ on the remote control to replay.

Press ㉓  again to quit playing completely.



### Note:

- Press  and  in the monitor perform the same function.



## Pause the Playback

During DVD playback, press ㉖  to switch between play and stop; During stop mode, press this button to resume playback mode.

### Note:



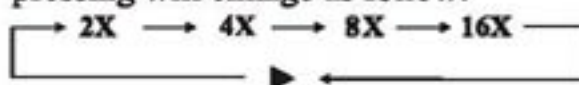

- Press  on the head unit or  in the monitor performs the same function.

## Skip backward/forward/F.F /F.REW the playback

Press ㉗ ( or ) on remote control to perform fast reward or fast forward. Each pressing will change as follow:



### Note:

- Press  and  on the head unit or  and  in the monitor perform the same function.

## Number Buttons

Press one of ㉘ **Number Buttons(0~9)** to select a track, it will be played automatically.

### Note:

- The function is only valid on remote control.
- Press ㉙ CLEAR to clear the mistake input.

## Repeat Playing

During DVD playback, press ㉚ **RPT** on the remote control to perform replaying function as followings:

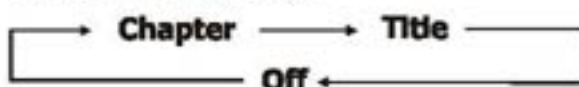

### Note:

- This function is only valid on remote control.
- The default setting is Disc Repeat.

## System Switch

During playback mode, Press **1** P/N on remote control to set the TV standard to PAL or NTSC or AUTO system.

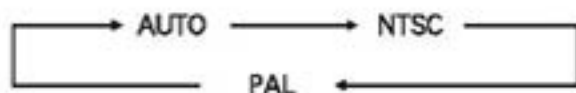

### Note:

- The function can be operated by selecting the DVD MENU SETUP.

## Slow motion playback

During DVD mode, press **6** **1/2** to slow forward or slow backward. There are speeds as follow:

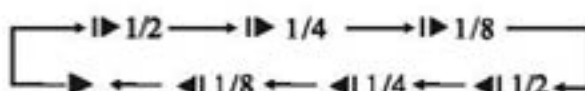

### Note:

- The function is only valid on remote control.

## Increase the size of the picture

During DVD mode, Press **9** **ZOOM** to increase the picture in size. There are sizes as follow, Each pressing increases the size until the maximum size is reached.

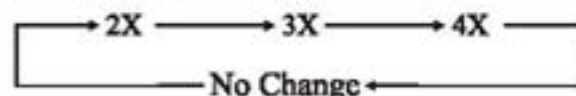

### Note:

- The function is only valid on remote control.
- To remove the image by pressing **27** button.

## On Screen Display

During DVD status, brief press **3** **OSD** button the display shows:

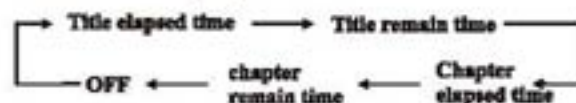

Press and hold **3** **OSD** to display the current setup.

### Note:

- The function is only valid on remote control.

## DVD Playback Setting

During DVD mode, press **2** **GOTO** button to set the playing time, when the TFT display : *title/chapter/sound/captions/angle/title time/chapter time/repeat playing/time option*. Press **27** [**▲**] [**▼**] to select the options, press ENTER to set the status. Then press **NUMBER BUTTONS** or **27** [**▶**] [**◀**] to set the current status.

### Note:

- This function is operated by using the remote control.

## Changing the viewing angle (Multi-angle)

With DVDs featuring multi-angle (scenes shot from multiple angles) recordings, you can press **7** **ANGLE** to switch among viewing angles during playback.

Selection options switch as follows:

**ANGLE 1** — **ANGLE 2** — **ANGLE 3**

### Notes:

- This function is operated by using the remote control.
- This function only operates with DVDs featuring multi-angle recordings.
- The "3" mark on a DVD's package indicates it features multi-angle scenes. The number in the "3" mark indicates the number of angles from which scenes were shot.
- It is invalid to pressing ANGLE during fast forward/fast reverse or pause.

## Changing audio language (Multi-audio)

DVDs can provide audio playback with different language. With DVDs featuring multi-audio recordings, you can press **6** **AUDIO** to switch between language and audio systems during playback.

Selection options switch as follows:

**AUDIO 1** — **AUDIO 2** — **AUDIO 3**

### Note:

- This function is operated by using the remote control.
- This function only operates with DVDs featuring multi-audio recordings.
- The number in the “**6**” mark on a DVD's package indicates the number of recorded languages/audio systems.

## Changing the subtitle language (Multi-subtitle)

With DVDs featuring multi-subtitle recordings. You can press **6** **SUB-T** to switch between subtitle languages during playback.

Selection options switch as follows:

**Subtitles 1** — **Subtitles 2** — **Subtitles OFF**

### Note:

- This function is operated by using the remote control.
- This function only operates with DVDs featuring multi-subtitle recordings.
- The number in the “**6**” mark on a DVD's package indicates the number of recorded subtitle languages.

## Selecting MENU

- 1 **Selecting Menu:** During DVD status, press **4** **MENU** to return to the root menu, all of the chapters will appear on monitor. You can press **27** or **28** button to select your desired chapter.
- 2 **Selecting Title:** During DVD status, press **3** **TITLE** to return the title menu, all of the titles will appear on monitor. You also can press **27** or **28** button to select your desired chapter.

### Note:

- The function is only valid on remote control.

## DVD SETUP MENU

Briefly press **19** **SET UP** on remote control or press and hold **11** **MENU** on the head unit, main menu and sub-menu will appear on TFT, pressing **29** [**▲**] [**▼**] [**▶**] [**◀**] on remote control or **10** [**▲**] [**▼**] [**▶**] [**◀**] on head unit to select your desired items, then press **29** **ENTER** on remote control or **11** on head unit to confirm. Press **13** **⏪** to back out.

### Notes:

- The selections are the preferred options that will be chosen if they are available on a disc. If the disc that is inserted does not have the preferred option then the disc's own preference will be used.
- Regarding **SETUP MENU**, please refer to the following pages for more details.
- Some functions varies depending on the types of models or formats of the disc.
- Press **19** **SETUP** on the remote control or **11** **MENU** on the head unit to exit the menu setup.

**--General Setup Page--****TV Display**

Example showing how to set TV Display mode:

(Press ▲ or ▼)

--General Setup Page--

TV Display	Wide
Angle Mark	On
OSD Lang	Eng
Captions	Off
Screen Saver	On

Go To General Setup Page



(Press ►, ▲ or ▼, then press ENTER)

--General Setup Page--

TV Display	Wide	Normal/PS
Angle Mark	On	Normal/LB
OSD Lang	Eng	<b>Wide</b>
Captions	Off	
Screen Saver	On	

Set TV Display mode

**Angle Mark**

Example showing how to set picture mode:

(Press ▲ or ▼)

--General Setup Page--

TV Display	Wide
Angle Mark	On
OSD Lang	Eng
Captions	Off
Screen Saver	On

Go To General Setup Page



(Press ►, ▲ or ▼, then press ENTER)

--General Setup Page--

TV Display	Wide	
Angle Mark	On	<b>On</b>
OSD Lang	Eng	Off
Captions	Off	
Screen Saver	On	

Set Angle Mark

**OSD Lang**

Example showing how to set language mode:

(Press ▲ or ▼)

--General Setup Page--

TV Display	Wide
Angle Mark	On
OSD Lang	Eng
Captions	Off
Screen Saver	On

Go To General Setup Page



(Press ►, ▲ or ▼, then press ENTER)

--General Setup Page--

TV Display	Wide	
Angle Mark	On	
OSD Lang	Eng	<b>English</b>
Captions	Off	
Screen Saver	On	

Set OSD Language



**--General Setup Page--****Captions**

Example showing how to set captions on/off:

(Press ▲ or ▼)

--General Setup Page--

TVDisplay	Wide
Angle Mark	On
OSD Lang	Eng
Captions	Off
Screen Saver	On

Go To General Setup Page



(Press ►, ▲ or ▼, then press ENTER)

--General Setup Page--

TVDisplay	Wide	
Angle Mark	On	
OSD Lang	Eng	
Captions	Off	On
Screen Saver	On	Off

Closed Captions

**Screen Saver**

Example showing how to set Screen Saver on/off:

(Press ▲ or ▼)

--General Setup Page--

TVDisplay	Wide
Angle Mark	On
OSD Lang	Eng
Captions	Off
Screen Saver	On

Go To General Setup Page



(Press ►, ▲ or ▼, then press ENTER)

--General Setup Page--

TVDisplay	Wide	
Angle Mark	On	
OSD Lang	Eng	
Captions	Off	
Screen Saver	On	On
		Off

Screen Saver

**--Dolby Digital Setup--****Dual Mono**

Example showing how to set stereo mode:

(Press ▲ or ▼ )

--Dolby Digital Setup--

Dual Mono

Dynamic

Go To Dolby Digital Setup



(Press ►, ▲ or ▼, then press ENTER)

--Dolby Digital Setup--

Dual Mono

Dynamic

Stereo

L-Mono

R-Mono

Mix-Mono

Dual Mono (1+1) Setup

**Dynamic**

Example showing how to set dynamic range compression:

(Press ▲ or ▼ )

--Dolby Digital Setup--

Dual Mono

Dynamic

Go To Dolby Digital Setup



(Press ►, ▲ or ▼, then press ENTER)

--Dolby Digital Setup--

Dual Mono

Dynamic

-- FULL

-- 3/4

-- 1/2

-- 1/4

-- OFF

Set DRC off

## ---Preference page---

**TV Type**

Example showing how to set TV type:

(Press ▲ or ▼)

--Preference Page--

TV Type	Auto
Audio	Eng
Subtitle	Eng
Disc Menu	Eng
Parental	
Password	
Default	

Go To Preference Page



(Press ►, ▲ or ▼, then press ENTER)

--Preference Page--

TV Type	Auto	PAL
Audio	Eng	Auto
Subtitle	Eng	NTSC
Disc Menu	Eng	
Parental		
Password		
Default		

Set TV Standard

**Audio**

Example showing how to set Audio language:

(Press ▲ or ▼)

--Preference Page--

TV Type	Auto
Audio	Eng
Subtitle	Eng
Disc Menu	Eng
Parental	
Password	
Default	

Go To Preference Page



(Press ►, ▲ or ▼, then press ENTER)

--Preference Page--

TV Type	Auto	
Audio	Eng	English
Subtitle	Eng	
Disc Menu	Eng	
Parental		
Password		
Default		

Preferred Audio Language

**Subtitle**

Example showing how to set subtitle language:

(Press ▲ or ▼)

--Preference Page--

TV Type	Auto
Audio	Eng
Subtitle	Eng
Disc Menu	Eng
Parental	
Password	
Default	

Go To Preference Page



(Press ►, ▲ or ▼, then press ENTER)

--Preference Page--

TV Type	Auto	
Audio	Eng	
Subtitle	Eng	English
Disc Menu	Eng	Off
Parental		
Password		
Default		

Preferred subtitle Language

## ---Preferences page--

**Disc Menu**

Example showing how to set Disc Menu Language:

(Press ▲ or ▼)

--Preference Page--

TVType	Auto
Audio	Eng
Subtitle	Eng
Disc Menu	Eng
Parental	
Password	
Default	

Go To Preference Page



(Press ►, ▲ or ▼, then press ENTER)

--Preference Page--

TVType	Auto	
Audio	Eng	
Subtitle	Eng	
Disc Menu	Eng	English
Parental		
Password		
Default		

Preferred Menu Language

**Parental**

Example showing how to set parental control:

(Press ▲ or ▼)

--Preference Page--

TVType	Auto
Audio	Eng
Subtitle	Eng
Disc Menu	Eng
Parental	
Password	
Default	

Go To Preference Page



(Press ►, ▲ or ▼, then press ENTER)

--Preference Page--

TVType	Auto	2 G ▲
Audio	Eng	3 PG
Subtitle	Eng	4 PG 13
Disc Menu	Eng	5 PGR
Parental		6 R
Password		7 NC 17
Default		8 Adult
		Off

Set Parental Control

**Password**

Example showing how to set password, and the default password is 8888.

(Press ▲ or ▼)

--Preference Page--

TVType	Auto
Audio	Eng
Subtitle	Eng
Disc Menu	Eng
Parental	
Password	
Default	

Go To Preference Page



(Press ►, ▲ or ▼, then press ENTER)

--Preference Page--

TVType	Auto	
Audio	Eng	
Subtitle	Eng	
Disc Menu	Eng	
Parental		
Password		Change
Default		

Change Password

## ---Preferences page---

**Default**

Example showing how to set load factory setting:

(Press ▲ or ▼)

--Preference Page--

TV Type	Auto
Audio	Eng
Subtitle	Eng
Disc Menu	Eng
Parental	
Password	
Default	

Go To Preference Page



(Press ►, ▲ or ▼, then press ENTER)

--Preference Page--

TV Type	Auto
Audio	Eng
Subtitle	Eng
Disc Menu	Eng
Parental	
Password	
Default	Reset

Load Factory Setting

## Playing a Mp3 Disc

Insert a MP3 disc into the slot, the unit will automatically switch on, if a MP3 disc is loaded, press SOURCE to start the playback. During MP3 playback, the moving playing information displays on LCD. When playing a disc included PIC file, first press **F** ■ , then press [▲][▼] to select the option.

### ▣ Note:

- You can eject a MP3 by pressing EJ button on the base or ▲ on the remote control or ▲ in the monitor.

## Selecting Tracks Fast

During Mp3 playback, press **21** ▲ to play the backward track, Press **21** ▼ to play next track.

### ▣ Note:

- Pressing ▲ and ▼ button on the head unit or also ◻◻ and ◻◻ in the monitor perform the same operation.

## Repeat Playing

During Mp3 playback , press **15** RPT to replay the current track, press it again to cancel this function.

### ▣ Note:

- This function is operated by using the remote control.
- The default setting is catalog Repeat.

## Number Buttons

Press one of **23** Number Buttons(0~9) to select a track to play automatically.

### ▣ Note:

- This function is operated by using the remote control.
- Press **22** CLEAR to clear the mistake input.

## Stop Playing

During Mp3 playback, Press **13** ■ to stop the playback.

### ▣ Note:

- Press ◻◻ in the monitor performs the same function.

## Selecting the MP3 Track

During Mp3 mode, firstly press **2** GOTO and the TFT shows:---. Then press **23** NUMBER BUTTONS to input the Mp3 track' s Number to play it,; secondly press GOTO button, and the TFT shows : --:-- , now input the desired Number to play the current track at this point, If there are some mistakes, press **22** CLEAR to clear them.

### ▣ Note:

- This function is operated by using the remote control.

# MP3

## Pause the Playback

During Mp3 playback, press **⏸** to switch between play and stop.

**Note:**

- Press **⏸** on the head unit or **⏸** in the monitor performs the same function.

## Skip backward/forward/F.F /F.REW the playback

Press **⏮** (**⏮** or **⏭**) on remote control to perform fast reward or fast forward.

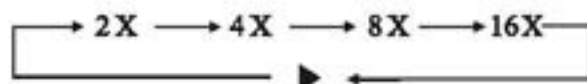

**Note:**

- Press **⏮** and **⏭** on the head unit or **⏮** and **⏭** in the monitor perform the same function.

## On Screen Display

Hold and press **Ⓞ** OSD button to display the current status.

## Playing a VCD/CD

Insert a VCD/CD disc into the slot, the unit will automatically switch on, if a disc is loaded, press SOURCE to start the playback.

### Note:

- You can eject a disc by pressing EJ button on the base or  $\blacktriangle$  on the remote control or  $\blacktriangle$  in the monitor.

## Selecting Tracks Fast

During VCD/CD playback, firstly press  $\text{⏮}$  to replay the current track, press  $\text{⏮}$  again to play the backward track, Press  $\text{⏭}$  to play next track.

### Note:

- Pressing  $\blacktriangle$  and  $\blacktriangledown$  button on the head unit or also  $\text{⏮}$  and  $\text{⏭}$  in the monitor perform the same operation.

## Repeat Playing

During VCD/CD playback, repeatedly press  $\text{⏮}$  RPT to perform replaying function, first press it to replay the current track, press it again to cancel this function.

### Note:

- This function is operated by using the remote control.
- The default setting is Disc Repeat.

## Playing Tracks at Random

During VCD/CD playback, pressing  $\text{⏮}$  RDM button on the remote control to play any track at random under the directory which you select. Press it again to return to normal playing.

### Note:

- This function is operated by using the remote control.

## Number Buttons

Press one of  $\text{0-9}$  Number Buttons(0~9) to select a track to play automatically.

### Note:

- This function is operated by using the remote control.
- Press  $\text{⏮}$  CLEAR to clear the mistake input.

## Stop Playing

During VCD/CD playback, firstly Press  $\text{⏮}$  button then press  $\text{⏮}$  or  $\text{⏭}$  to replay, press  $\text{⏮}$  again to stop the playback.

### Note:

- Press  $\text{⏮}$  in the monitor perform the same function.

## Pause the Playback

During VCD/CD playback, press  $\text{⏮}$  || to switch between play and stop.

### Note:

- Press  $\text{⏮}$  on the head unit or  $\text{⏮}$  in the monitor performs the same function.

## Skip backward/forward/F.F /F.REW the playback

Press  $\text{⏮}$  ( $\text{⏮}$  or  $\text{⏭}$ ) on remote control to perform fast reward or fast forward.

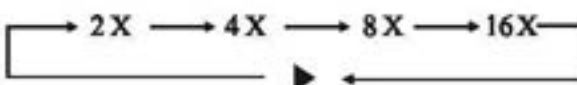

### Note:

- Press  $\text{⏮}$  and  $\text{⏭}$  on the head unit or  $\text{⏮}$  and  $\text{⏭}$  in the monitor perform the same function.



# VCD/CD

## System Switch

During VCD mode, Press **① P/N** on remote control to set the TV standard to PAL or NTSC or AUTO system.

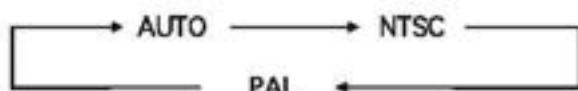

### Note:

- The function is only valid on remote control.

## Slow motion playback

During VCD mode, press **⑥** to slow forward or slow backward. There are speeds as follow:.

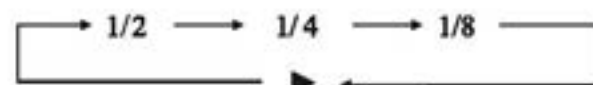

### Note:

- The function is only valid on remote control.

## Increase the size of the picture

During VCD mode, Press **⑨ ZOOM** to increase the picture in size. There are sizes as follow, Each pressing increases the size until the maximum size is reached.

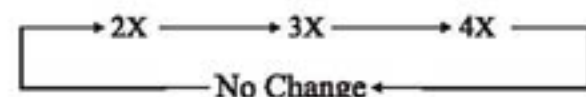

### Note:

- The function is only valid on remote control.
- To remove the image by pressing **⑲** button.

## On Screen Display

During VCD/CD status, brief press **③ OSD** button the display shows:

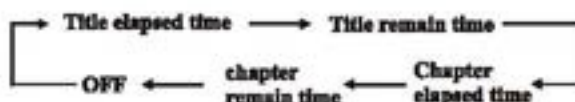

Press and hold **③ OSD** to display the current setup.

### Note:

- The function is only valid on remote control.

## Setting the Playback Time

During CD playback, firstly press **② GOTO**, and TFT shows : *disc playback time:--:--*, press your desired time of the playback by using number buttons.

Secondly press **GOTO** button, *the tracks time* appears on TFT, also input your desired numbers to play the current time of your selection.

During VCD mode, press **② GOTO** button to set the playing time, when the TFT display : *title/chapter/sound/captions/angle/title time/chapter time/repeat playing/time option*. Press **⑲** [**▲**] [**▼**] to select the options, press ENTER to set the status. Then press **⑲** NUMBER BUTTONS or **⑲** [**▶**] [**◀**] to set the current status.

### Note:

- This function is operated by using the remote control.

## Selecting Channel

During VCD status, repeatedly press **Ⓟ** AUDIO button to select the following channel:



Selecting the corresponding channel to set the different sound characters.

### ■ Note:

- The function is only valid on remote control.

## PBC Selector

During VCD status, firstly press **Ⓝ** TITLE button, the PBC playback starts and the menu of entire disc appears on LCD. And then you can select your desired track by using **Ⓢ** or **Ⓣ**. When a track is playing, you can press MENU to return to the menu, if you would like to end the track and select others. To cancel PBC playing, press **Ⓝ** TITLE button again.

### ■ Note:

- PBC playing confirms to version 2.0 or above disc only.

## Program Playing

During VCD/CD mode, press **Ⓟ** PROG, the TFT displays the program menu. Pressing **NUMBER BUTTONS** to select the track Number and then press **Ⓢ** to move the cursor to *START*, press ENTER to start program playing; move the cursor to EXIT and press ENTER to exit the program playing. Move the cursor to **⏮** and press ENTER to the last page; move the cursor to **⏭** and press **Ⓢ** ENTER to the next page.

During this process, press **Ⓝ** ■ or press **PROG** to cancel the program playing.

### ■ Note:

- The function is only valid on remote control.

# Tuner

## Listening to the radio



- 1 **Band Indicator**  
Shows which band the radio is tuned to.
- 2 **Preset Number Indicator**  
Shows what preset has been selected.
- 3 **Frequency Indicator**  
Shows which frequency the tuner is tuned.
- 4 **SEEK+/SEEK-**  
Briefly press to tune by the presettable range, hold and press to tune automatically.
- 5 **VOL+/VOL-**  
To increase or decrease the volume.
- 6 **BAND**  
To select the bands.
- 7 **AMS**  
Briefly press to scan the current station, hold and press to tune automatically.
- 8 **MENU**  
Press this button to set the main menu.
- 9 **SRC**  
Press this button to select the signal source.
- 10 **The 6 stations of the current band.**  
Briefly press to select station, hold and press to save the current station to one of the 6 stations.

## Band Selector

During radio status, repeatedly press **BAND** button to select bands in the following order:

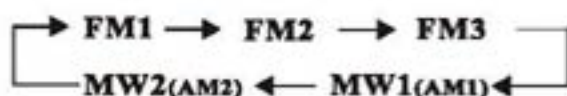

### Note:

- Press BAND/▶ on the head unit or BAND in the monitor performs the same function.

## Manual/Automatic Tuning

**Manual Tuning:** Press **▶** or **◀** button on the remote control continuously to select a station downward or upward respectively.

**Automatic Tuning:** Press and hold **▶** or **◀** button for more than 3 seconds, the radio automatically searches a station downward or upward respectively and plays when it finds a station.

### Note:

- Press **▶** and **◀** button on the head unit or **▶** in the monitor performs the same function.

## DX/LOC Selector

During radio status, press **LOC** button to select strong or weak station reception.

"**LOC**" appears on the display and only local station is available. when it disappears both distance and local stations can be received.

### Note:

- The function is only valid on remote control.
- The function is invalid in AM tuning.

## Selecting the Stored Station

During radio status, press **▲** button to select the stored station upward, press **▼** to select the stored station downward.

### Note:

- Press **▲** or **▼** button on the head unit performs the same function.

## MO/ST Selector

During radio status, you can press **6** **ST** button on the remote control to select **MONO** mode or **STEREO** mode.

Stereo reception is charged when “stereo” appears.

It is switched to **MONO** mode when “mono” appears.

### ▣ Note:

- \* It is only valid on remote control.
- \* Switch to **MONO** compulsively to improve the listening quality when weak signal.
- \* It is only valid in FM tuning.

## Scanning/Memorizing Stations Automatically

During radio status, you can press **4** **AMS** button on the remote control to scan each stored station 5 seconds respectively which stored in **23** Number Buttons (from 1 to 6). You can press the corresponding Number Buttons or **AMS** button when your desired station is charged. And it starts playing that station.

When press and hold **4** **AMS** button for more than 2 seconds, it will activate automatically memory storing function. The radio automatically selects a station and has it stored in any one of the **23** **Number Buttons (from 1 to 6)**.

### ▣ Note:

- \* The unit can be stored up to 6 stations for each band.
- \* Press **7** in the monitor performs the same function.

## Number Buttons

During radio status, press **Number Buttons** to receive the stored stations.

During radio status, **Number Buttons (from 1 to 6)** **23** can help you store your favorite station. You can follow the steps as below:

- 1 When receiving a station, press and hold any one of the **Number Buttons (from 1 to 6)** until the number appears on the **LCD**, which indicates that station is already stored in the corresponding number button.
- 2 Press **4** **AMS** button to receive stations automatically, and store them in 1 to 6 number respectively.
- 3 Press and hold another number button more than 2 seconds when listening in a station in one number button's, the station will be stored in that number button.

### ▣ Note:

- \* Press **10** in the monitor performs the same function.

## On Screen Display

During radio status, keep pressing **8** **OSD** to display the current mode

# TV(optional)

## On Screen Display

During radio status, keep pressing **8** OSD to display the current mode

## TV Station Selector 1

Press **23** on the remote control to select the TV stations, press 1 to 9 button to select the stations directly; to select more than 10 station, firstly press **2** GOTO button, then press the corresponding number.

### Note:

- Press **2** in the monitor also performs the same function.

## TV Station Selector 2

Press **24** ▲ on the remote control to select the TV stations upwards, press ▼ to select stations downwards.

### Note:

- Press ▲ and ▼ on the head unit or **1** in the monitor also perform the same function.

## Frequency Searching

Keep press **25** ► to select the frequency upwards, press ◀ to select downwards.

### Note:

- Press ► and ◀ on the head unit or **4** in the monitor also perform the same function.

## Adjusting Frequency Manually

Press **26** ►/◀ to adjust the current frequency manually, in order to make the current picture up to the best or to find the known frequency.

### Note:

- Press ► and ◀ on the head unit or **4** in the monitor also perform the same function.

## TV Setup Menu

Press SRC in the monitor, then press TV SET to enter the menu as follows:

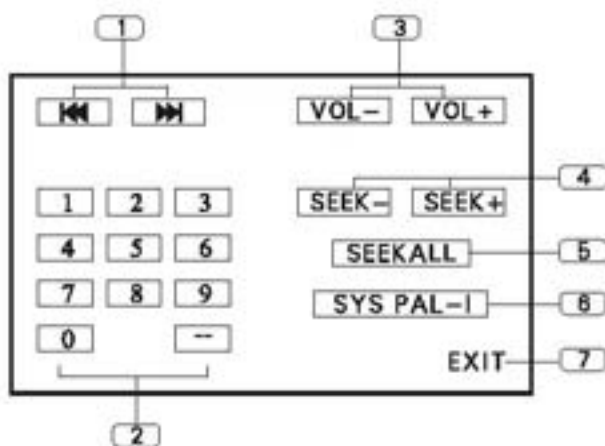

### 1 ◀ / ▶

To select stations upwards or downwards.

### 2 Station Selector

To select 1 to 30 stations.

### 3 VOL+ / VOL-

To increase or decrease the volume.

### 4 SEEK+ / SEEK-

Briefly press to select frequency, hold and press to tune.

### 5 SEEKALL

Press to tune automatically and save the stations too.

### 6 SYSTEM

Please according to the local area to set the TV system, to make sure the receiving is the best.

### 7 EXIT

## Simple Troubleshooting Guide

The following checklist might help to solve the problems which you meet when using the unit. Please double check and make sure if the connection and the procedure of the operation is properly before using the checklist below .

<b>Problem</b>	<b>Cause/Solution</b>
<b>No power.</b>	<ul style="list-style-type: none"> <li>• Check and make sure whether the fuse is blown, replace with the proper value if necessary.</li> </ul>
<b>Some errors occur in the LCD or no function when pressing the button.</b>	<ul style="list-style-type: none"> <li>• Press <b>RESET</b> button.</li> </ul>
<b>Unable to receive stations.</b>	<ul style="list-style-type: none"> <li>• Check and make sure whether the antenna is inserted or the antenna is properly connected, if not, insert the antenna or connect it properly.</li> </ul>
<b>Poor effect on receiving a station.</b>	<ul style="list-style-type: none"> <li>• Antenna may not be the proper length. Make sure the antenna is fully extended; if broken, replace the antenna with a new one.</li> <li>• The antenna is poorly grounded, check and make sure the antenna is properly grounded at its mounting location. .</li> </ul>
<b>CDs cannot be loaded.</b>	<ul style="list-style-type: none"> <li>• A CD is loaded in the mechanism.</li> </ul>
<b>Sound skips.</b>	<ul style="list-style-type: none"> <li>• The CD is dirty or damaged.</li> </ul>
<b>No images.</b>	<ul style="list-style-type: none"> <li>• The Video line from main unit to the TV is not connected properly.</li> </ul>
<b>Images skip.</b>	<ul style="list-style-type: none"> <li>• Improper setting of the color system. Set the color system to "PAL" or "NTSC" according to the connected television.</li> </ul>

**Note:**

If any of the problem persist after check list had been made, consult your nearest service dealer. Never attempt to disassemble your unit by yourself.



**Due to continuous product improvement, the operations are subject to run the model.**